



## **TOUGHSwitch™ PoE**

5-Port Power over Ethernet Managed Switch  
8-Port Power over Ethernet Managed Switch PRO

Models: TS-5-POE, TS-8-PRO

USER GUIDE

# Table of Contents

---

<b>Chapter 1: Overview</b> .....	1
Introduction .....	1
Package Contents .....	1
Configuration Interface System Requirements .....	1
Hardware Overview .....	1
<b>Chapter 2: Installation</b> .....	4
Introduction .....	4
Configuration .....	4
Installation of the TOUGHSwitch PoE .....	4
Installation of the TOUGHSwitch PoE PRO .....	6
<b>Chapter 3: Navigation</b> .....	7
Accessing the Configuration Interface .....	7
Product Verification .....	8
Interface Tabs .....	8
<b>Chapter 4: Status Tab</b> .....	9
Status .....	10
Port Status .....	10
Port Statistics .....	10
Total Throughput .....	11
Data Distribution .....	11
Details for Port .....	11
<b>Chapter 5: Device Tab</b> .....	13
Management Network Settings .....	14
Basic Settings .....	15
Management Connection Settings .....	15
Services .....	16
Spanning Tree Protocol .....	17
Jumbo Frames .....	17
Device Discovery .....	17
System Accounts .....	17
Maintenance .....	18
<b>Chapter 6: Ports Tab</b> .....	19
Basic Settings for Port .....	20
Ping Watchdog for Port .....	20
Spanning Tree Settings for Port .....	21
Configure Alerts for Port .....	21

<b>Chapter 7: VLANs Tab</b> .....	22
VLANs.....	22
<b>Chapter 8: Alerts Tab</b> .....	24
Alert Log .....	24
System Log.....	25
<b>Chapter 9: Tools</b> .....	26
Ping.....	26
Traceroute .....	27
Discovery .....	27
<b>Appendix A: Specifications</b> .....	28
<b>Appendix B: Safety Notices</b> .....	30
Electrical Safety Information .....	30
<b>Appendix C: Warranty</b> .....	31
General Warranty.....	31
<b>Appendix D: Compliance Information</b> .....	32
FCC .....	32
Industry Canada.....	32
CE Marking.....	32
RoHS/WEEE Compliance Statement.....	32
<b>Appendix E: Declaration of Conformity</b> .....	34
<b>Appendix F: Contact Information</b> .....	35
Ubiquiti Networks Support .....	35

# Chapter 1: Overview

## Introduction

Thank you for purchasing the Ubiquiti TOUGHSwitch™ PoE, which is part of the TOUGHSwitch series:

Name	Model	Description
TOUGHSwitch PoE	TS-5-POE	5-port managed switch featuring 24V PoE
TOUGHSwitch PoE PRO	TS-8-PRO	8-port managed switch featuring 24V or 48V PoE
TOUGHSwitch PoE CARRIER (coming soon)	TS-16-CARRIER	Two TOUGHSwitch PoE PROs mounted in a rack

The TOUGHSwitch is a managed switch designed to deliver Power over Ethernet (PoE) on the 10/100/1000 ports you have configured for PoE. It also features a variety of features, including port monitoring, system connection and management services, Virtual Local Area Network (VLAN) configuration, Spanning Tree Protocol (STP), *Ping Watchdog*, and alerts setup.

This User Guide is designed to provide instructions about installation of the TOUGHSwitch and to provide details about how to set up and use the Configuration Interface. This intuitive interface allows you to conveniently manage your TOUGHSwitch using your web browser.

## Package Contents

### TOUGHSwitch PoE



TOUGHSwitch PoE

M2.9x20 Screws  
(Qty. 2)M2.9 Anchors  
(Qty. 2)

Quick Start Guide

Power Adapter  
(24V, 2.5A)

Power Cord

### TOUGHSwitch PoE PRO



TOUGHSwitch PoE PRO



Quick Start Guide



Power Cord

## Configuration Interface System Requirements

- Microsoft Windows XP, Windows Vista, Windows 7, Linux, or Mac OS X
- Java Runtime Environment 1.6 (or above)
- Web Browser: Mozilla Firefox, Apple Safari, Google Chrome, or Microsoft Internet Explorer 8 (or above)

## Hardware Overview

Proceed to the description for your TOUGHSwitch model:

- **TOUGHSwitch PoE** Go to **“TOUGHSwitch PoE” on page 2** for the description.
- **TOUGHSwitch PoE PRO** Go to **“TOUGHSwitch PoE PRO” on page 3** for the description.

## TOUGHSwitch PoE

### Back Panel

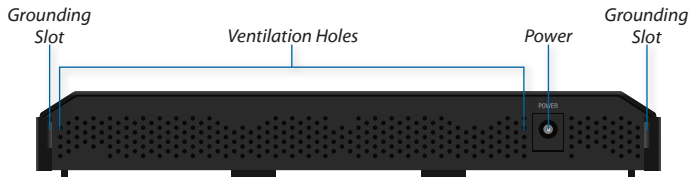

### Front Panel Ports

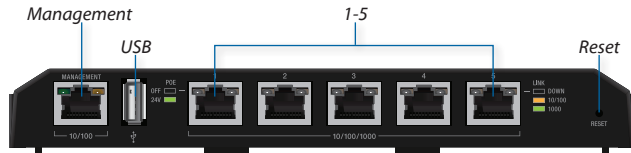

Interface	Description
Management	10/100 Mbps port for management. Traffic between the <i>Management</i> port and numbered ports will be limited to 10/100 Mbps and, under heavy load, may cause performance degradation of the TOUGHSwitch.
USB	Reserved for future use.
1-5	10/100/1000 Mbps ports for switching and PoE (also available for management by default).
Reset	To reset to factory defaults, press and hold the <b>Reset</b> button for more than 10 seconds while the unit is already powered on.

### Front Panel LEDs

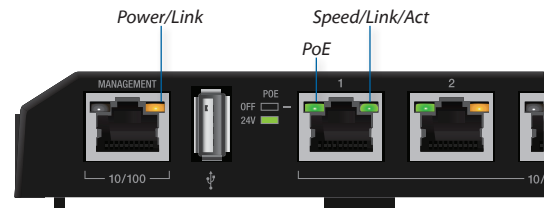

LED	State	Status	
Management	Power/Link	Off	No Link
	Power/Link	Amber	After bootup, the LED indicates power. After an initial link is established, the LED indicates a 10/100 Mbps connection. If the link terminates, the LED turns off until a link is re-established. If the unit reboots, the LED will again indicate power until a link is established.
Management	Power/Link	Amber Flashing	After the <i>Reset</i> button is held for more than 10 seconds, the unit is reset to factory defaults.
	1-5	PoE	Off
PoE		Green	24V Power over Ethernet
1-5	Speed/Link/Act	Off	No Link
		Amber	Link Established at 10/100 Mbps
		Amber Flashing	Link Activity at 10/100 Mbps
		Green	Link Established at 1000 Mbps
1-5	Speed/Link/Act	Green Flashing	Link Activity at 1000 Mbps

## TOUGHSwitch PoE PRO

### Back Panel

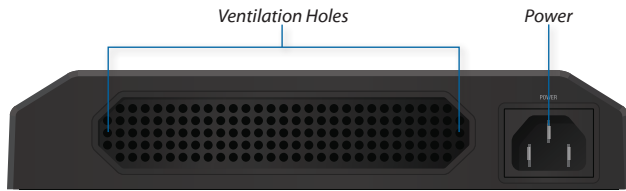

 **Note:** There are additional ventilation holes on the top and sides of the TOUGHSwitch.

### Front Panel Ports

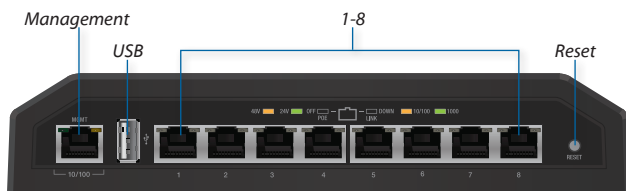

Interface	Description
Management	10/100 Mbps port for management. Traffic between the <i>Management</i> port and numbered ports will be limited to 10/100 Mbps and, under heavy load, may cause performance degradation of the TOUGHSwitch.
USB	Reserved for future use.
1-8	10/100/1000 Mbps ports for switching and PoE (also available for management by default).
Reset	To reset to factory defaults, press and hold the <b>Reset</b> button for more than 10 seconds while the unit is already powered on.

### Front Panel LEDs

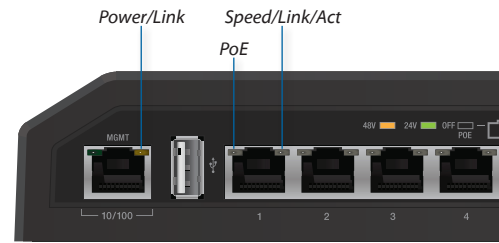

LED	State	Status	
Management	Power/Link	Off	No power
	Power/Link	Amber	After bootup, the LED indicates power. After an initial link is established, the LED indicates a 10/100 Mbps connection. If the link terminates, the LED turns off until a link is re-established. If the unit reboots, the LED will again indicate power until a link is established.
		Amber Flashing	After the <i>Reset</i> button is held for more than 10 seconds, the unit is reset to factory defaults.
1-8	PoE	Off	No Power over Ethernet
		Green	24V Power over Ethernet
		Amber	48V Power over Ethernet
	Speed/Link/Act	Off	No link
		Amber	Link established at 10/100 Mbps
		Amber Flashing	Link activity at 10/100 Mbps
		Green	Link established at 1000 Mbps
Green Flashing	Link activity at 1000 Mbps		

## Chapter 2: Installation

### Introduction

Proceed to the instructions for your TOUGHSwitch model:

- **TOUGHSwitch PoE** The instructions are below.
- **TOUGHSwitch PoE PRO** Go to **“Installation of the TOUGHSwitch PoE PRO” on page 6** for instructions.

### Configuration

After you install the TOUGHSwitch, refer to the instructions in **“Navigation” on page 7**, which explain how to access the Configuration Interface.

### Installation of the TOUGHSwitch PoE

Mount the TOUGHSwitch on a wall, or place it on a bench top.



**Note:** Keep 20 mm of clearance next to the ventilation holes for adequate airflow.

### Installation Requirements

- Drill, 6 mm drill bit, and Phillips screwdriver (wall-mounting)
- For indoor applications, use Category 5 (or above) UTP cabling approved for indoor use.
- For outdoor applications, shielded Category 5 (or above) cabling should be used for all wired Ethernet connections and should be grounded through the AC ground of the power supply. We recommend that you protect your outdoor networks from the most brutal environments and devastating ESD attacks with industrial-grade shielded Ethernet cable from Ubiquiti Networks™. For more details, visit: [www.ubnt.com/toughcable](http://www.ubnt.com/toughcable)



**Note:** Although the cabling can be located outdoors, the TOUGHSwitch itself should be housed inside a protective enclosure.

### Wall-Mounting (Optional)

To mount the TOUGHSwitch on a wall:

1. Use a 6 mm drill bit to drill two holes 60 mm apart.
2. Insert the *M2.9 Anchors* into the holes.
3. Use a Phillips screwdriver to secure a *M2.9x20 Screw* to each anchor. Leave a clearance of approximately 3 mm between each screw head and its anchor.

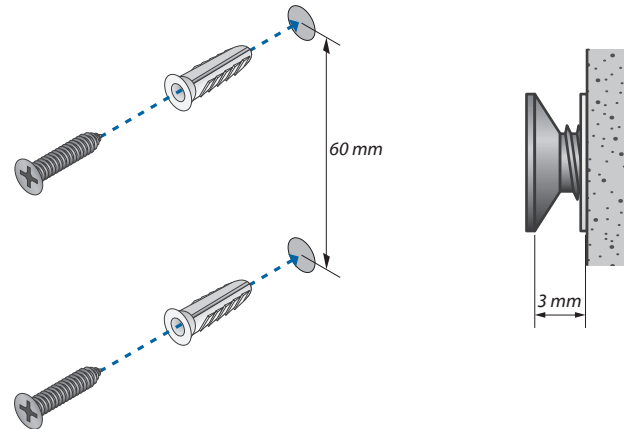

**Note:** You can also mount the TOUGHSwitch in a horizontal orientation.

4. Position the *Wall-Mount Slots* of the TOUGHSwitch over the screw heads on the wall. Then slide the TOUGHSwitch to the left to lock it into place.

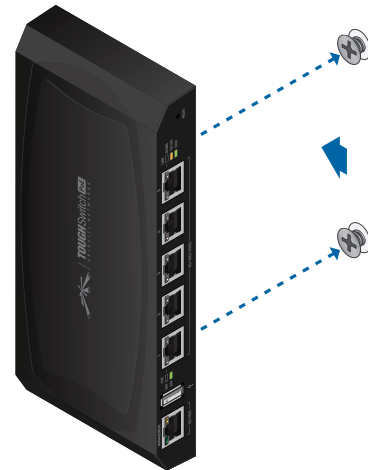

## Grounding the TOUGHSwitch (Optional)

The TOUGHSwitch is grounded through the *Power Adapter*; however, you can add optional ESD grounding for enhanced ESD protection.

1. Insert a ground wire (not included) through a corner slot.

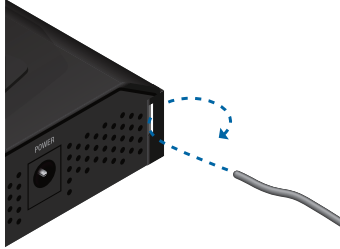

2. Twist tie to secure the ground wire to the TOUGHSwitch.
3. Secure the other end of the ground wire to a grounding block.

## Connecting Power

1. Connect the power connector of the *Power Adapter* to the *Power* port of the TOUGHSwitch.



2. Connect the *Power Cord* to the power port on the *Power Adapter*. Connect the other end of the *Power Cord* to a power outlet.

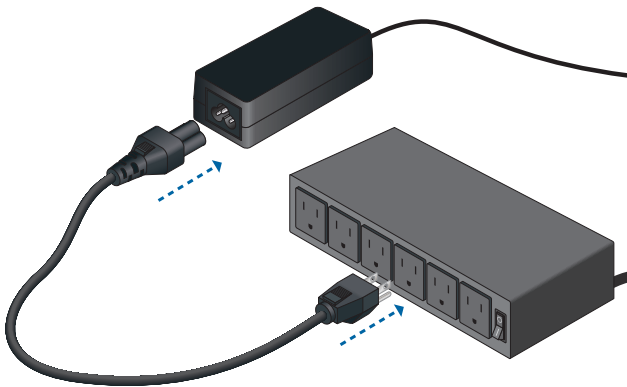



## Connecting Ethernet

1. Connect an Ethernet cable from the Ethernet port of your computer to the *Management* port of the TOUGHSwitch.

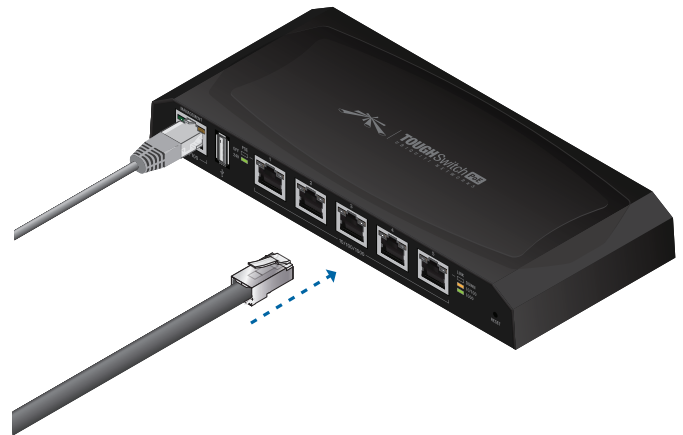

2. Connect Ethernet cables from the Ethernet ports of your devices to the numbered ports of the TOUGHSwitch.



 **Note:** *PoE* is disabled by default on all numbered ports and is not available on the *Management* port. To enable *PoE* on the appropriate ports, use the *Ports* tab in the Configuration Interface (see **"PoE" on page 20**).



## Installation of the TOUGHSwitch PoE PRO

Place the TOUGHSwitch on a bench top or other flat surface.



**Note:** Keep 20 mm of clearance next to the ventilation holes for adequate airflow.

### Installation Requirements

- For indoor applications, use Category 5 (or above) UTP cabling approved for indoor use.
- For outdoor applications, shielded Category 5 (or above) cabling should be used for all wired Ethernet connections and should be grounded through the AC ground of the power supply. We recommend that you protect your outdoor networks from the most brutal environments and devastating ESD attacks with industrial-grade shielded Ethernet cable from Ubiquiti Networks™. For more details, visit: [www.ubnt.com/toughcable](http://www.ubnt.com/toughcable)



**Note:** Although the cabling can be located outdoors, the TOUGHSwitch itself should be housed inside a protective enclosure.

### Connecting Power

1. Connect the *Power Cord* to the *Power* port of the TOUGHSwitch.



2. Connect the other end of the *Power Cord* to a power outlet.

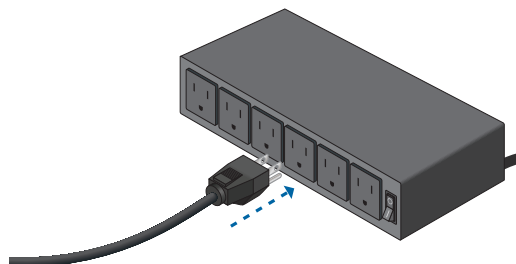

### Connecting Ethernet

1. Connect an Ethernet cable from the Ethernet port of your computer to the *Management* port of the TOUGHSwitch.



2. Connect Ethernet cables from the Ethernet ports of your devices to the numbered ports of the TOUGHSwitch.



**Note:** *PoE* is disabled by default on all numbered ports and is not available on the *Management* port. To enable *PoE* on the appropriate ports, use the *Ports* tab in the Configuration Interface (see [“PoE” on page 20](#)).

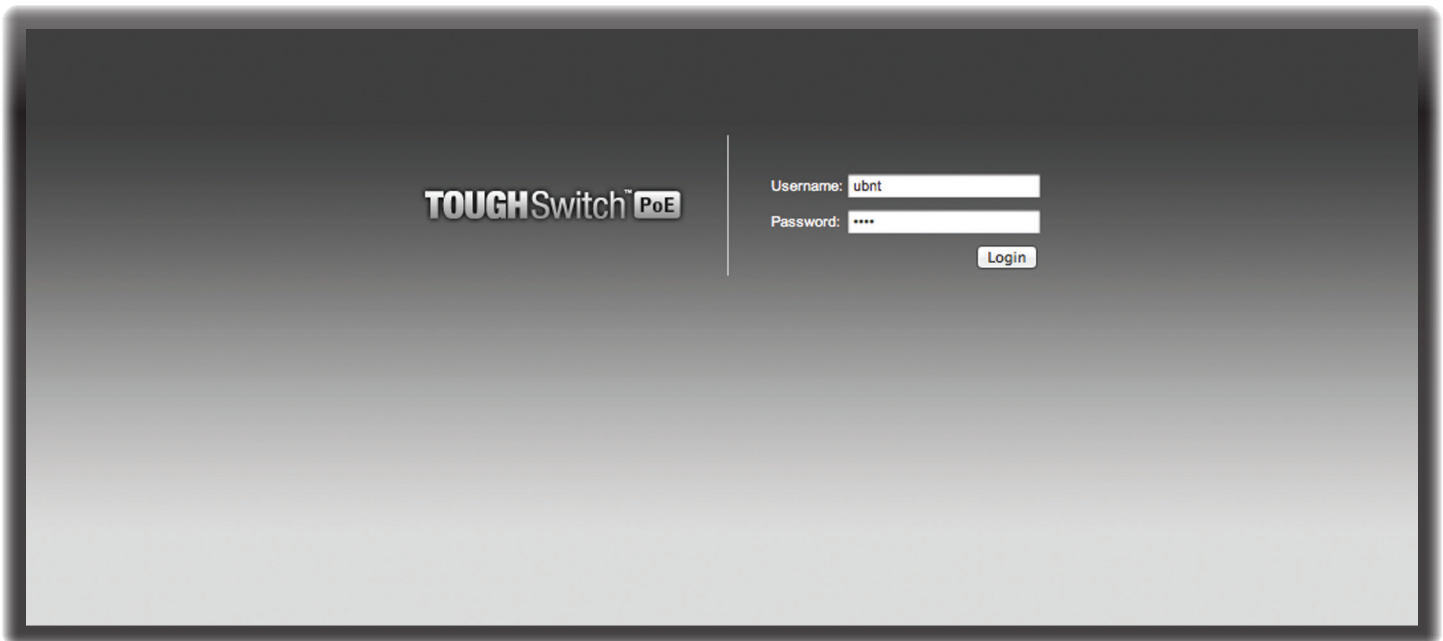

## Chapter 3: Navigation

The Configuration Interface is an advanced operating system accessed through a simple and intuitive user interface. The TOUGHSwitch uses the Configuration Interface for convenient configuration and management via a web browser.

### Accessing the Configuration Interface

Connect to the Configuration Interface by performing the following steps:

1. Ensure that your computer (or other host machine) is connected to the *Management* port on the TOUGHSwitch.



**Note:** By default, you can configure the TOUGHSwitch via any port; however, we recommend the *Management* port. (Access to the Configuration Interface can be limited to the *Management* port only. You can configure this setting on the *Device* tab; see **“Management Network Settings” on page 14.**)

2. Configure the Ethernet adapter on your host system with a static IP address on the 192.168.1.x subnet (for example, 192.168.1.100).
3. Launch your web browser. Type **https://192.168.1.20** in the address field. Press **enter** (PC) or **return** (Mac).



4. The login screen will appear. Enter **ubnt** in the *Username* and *Password* fields. Click **Login**.

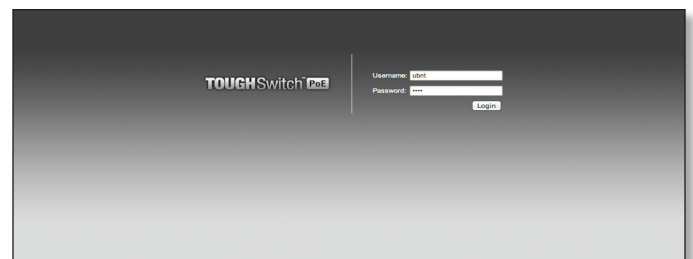

5. The Configuration Interface will appear, allowing you to customize your settings as needed. You can enable PoE on the *Ports* tab; see **“PoE” on page 20.**

## Product Verification

The Configuration Interface will verify whether a product is genuine or counterfeit.

For a genuine TOUGHSwitch, the Configuration Interface will display a Genuine Product logo in the lower left corner of the screen.



For any product that is not an official Ubiquiti product, the Configuration Interface will display a counterfeit warning. Please contact Ubiquiti at [support@ubnt.com](mailto:support@ubnt.com) regarding this product.



## Interface Tabs

The Configuration Interface contains five main tabs, each of which provides a web-based management page to configure a specific aspect of the TOUGHSwitch. This User Guide covers each tab with a chapter. For details on a specific tab, refer to the appropriate chapter.

- **Status** The **“Status Tab” on page 9** displays status information and statistics for each port.
- **Device** The **“Device Tab” on page 13** configures system settings and services for the TOUGHSwitch.
- **Ports** The **“Ports Tab” on page 19** configures settings and services for each port.
- **VLANs** The **“VLANs Tab” on page 22** configures Virtual Local Area Networks (VLANs) for the various ports.
- **Alerts** The **“Alerts Tab” on page 24** displays alerts if alert logging is configured and system log messages if system logging is enabled.

Each page also contains network administration and monitoring tools:

- **“Ping” on page 26**
- **“Traceroute” on page 27**
- **“Discovery” on page 27**

**TOUGHSwitch™ PoE**

STATUS | DEVICE | PORTS | VLANS | ALERTS | Tools: | Logout

Total Throughput 496 TX bps | 496 RX bps

**Status**

Device Name: TOUGHSwitch PoE | Date: 2012-06-14 16:27:08  
 Device Location: | Uptime: 00:03:14  
 Firmware: SW.v1.0 | Device MAC: 00:27:22:76:C8:4C

**Port Status**

Port	Name	Port Status	Link Status	PoE	STP State	MTU	Alerts
1	Port 1	Enabled	100Mbps-Full	24V	Forwarding	9216	On
2	Port 2	Enabled	100Mbps-Full	24V	Forwarding	9216	Off
3	Port 3	Enabled	100Mbps-Full	24V	Blocking	9216	Off
4	Port 4	Enabled	Down	Off	Blocking	9216	Off
5	Port 5	Enabled	Down	Off	Blocking	9216	Off

**Port Statistics**

Port	Name	RX Data	RX Packets	RX Errors	TX Data	TX Packets	TX Errors
1	Port 1	2262	28	0	18161	111	0
2	Port 2	1020	12	0	18277	112	0
3	Port 3	18735	114	0	1088	17	0
4	Port 4	0	0	0	0	0	0
5	Port 5	0	0	0	0	0	0

**Total Throughput**

**Data Distribution**

© Copyright 2006-2012 Ubiquiti Networks, Inc.

## Chapter 4: Status Tab

The *Main* tab displays a summary of the link status information, current values of the basic configuration settings, network settings and information, and traffic statistics.

The TOUGHSwitch image displays the active LEDs and connections. See **“Hardware Overview” on page 1** for more information.



Total Throughput for TX and RX are also displayed.

Total Throughput	496	496
	TX bps	RX bps

Place your mouse over a port to view its PoE status, Speed setting, duplex mode, and statistics for TX and RX throughput.

Port 1	7.55	9.73
PoE: 24V	TX kbps	RX kbps
Speed: 100Mbps-Full		

## Status

Status	
Device Name: TOUGHSwitch PoE	Date: 2012-06-14 18:27:08
Device Location:	Uptime: 00:03:14
Firmware: SW.v1.0	Device MAC: 00:27:22:76:C8:4C

**Device Name** Displays the customizable name or identifier of the device. The *Device Name* (also known as host name) is displayed in registration screens and discovery tools.

**Device Location** Displays the description of the device's location.

**Firmware** Displays the firmware version of the Configuration Interface.

**Date** Displays the current system date and time. The date and time are displayed in YEAR-MONTH-DAY HOURS:MINUTES:SECONDS format. The system date and time is retrieved from the Internet using NTP (Network Time Protocol). The *NTP Client* is disabled by default on the *Device* tab. The device doesn't have an internal clock, and the date and time may be inaccurate if the *NTP Client* is disabled or the device isn't connected to the Internet.

**Uptime** This is the total time the device has been running since the latest reboot (when the device was powered up) or software upgrade. The time is displayed in days, hours, minutes, and seconds.

**Device MAC** Displays the Media Access Control (MAC) address of the device.

## Port Status

Port	Name	Port Status	Link Status	PoE	STP State	MTU	Alerts
1	Port 1	Enabled	100Mbps-Full	24V	Forwarding	9216	On
2	Port 2	Enabled	100Mbps-Full	24V	Forwarding	9216	Off
3	Port 3	Enabled	100Mbps-Full	24V	Blocking	9216	Off
4	Port 4	Enabled	Down	Off	Blocking	9216	Off
5	Port 5	Enabled	Down	Off	Blocking	9216	Off

**Port** Displays the number of the port.

**Name** Displays the name of the port.

**Port Status** Displays the activity status of the link connection.

**Link Status** Displays the speed and duplex mode of the port. If the port is inactive, "Down" is displayed.

**PoE** Displays the status and voltage of the PoE feature. 24V is displayed in green. 48V\* is displayed in orange (\*available only on the TOUGHSwitch PoE PRO).

**STP State** Displays the Spanning Tree Protocol (STP) state if STP is enabled on the *Device* tab. Displayed STP states include *Blocking*, *Learning*, and *Forwarding*. (See "**Spanning Tree Protocol**" on page 17 for more information.)

**MTU** Displays the Maximum Transmission Unit (MTU), which is the maximum packet size (in bytes) that a network can transmit.

**Alerts** Displays whether alerts are set on this port.

## Port Statistics

Port	Name	RX Data	RX Packets	RX Errors	TX Data	TX Packets	TX Errors
1	Port 1	2262	28	0	18161	111	0
2	Port 2	1020	12	0	18277	112	0
3	Port 3	18735	114	0	1066	17	0
4	Port 4	0	0	0	0	0	0
5	Port 5	0	0	0	0	0	0

**Raw/Human Readable** The statistics are available in two formats. Click the format you prefer.

- Raw** Displays data in bytes. *Raw* format is more detailed because some bytes are not displayed in *Human Readable* format, which displays up to three decimal places. For example, if data is displayed in GB, bytes are not counted until they reach a total of 1 MB. If 1 GB is displayed, the next number that will be displayed is 1.001 GB (1 GB + 1 MB = 1.001 GB).
- RX/TX Packets** For the 5-Port TOUGHSwitch PoE only, you can hold your mouse over the statistic to display a popup with packet size details.

RX Packet Size for Port 1	
64 Bytes:	6537
65 - 127 Bytes:	1450
128 - 255 Bytes:	4451
256 - 511 Bytes:	0
512 - 1023 Bytes:	0
1024 - 1518 Bytes:	0
MaxBytes:	0

- RX/TX Errors** If there are errors, you can hold your mouse over the statistic to display a popup with error details.

RX Errors for Port 1	
RxFragment:	15

- Human Readable** Displays data in megabytes (MB), kilobytes (kB), gigabytes (GB), or terabytes (TB).

Port	Name	RX Data	RX Packets	RX Errors	TX Data	TX Packets	TX Errors
1	Port 1	2.2 KB	28	0	19.8 KB	132	0
2	Port 2	1020 Bytes	12	0	19.9 KB	133	0
3	Port 3	20.3 KB	135	0	1.1 KB	17	0
4	Port 4	0	0	0	0	0	0
5	Port 5	0	0	0	0	0	0

**Port** Displays the number of the port.

**Name** Displays the name of the port.

**RX Bytes/Data** Displays the amount of data received. *RX Bytes* displays the amount in *Raw* format (actual number of bytes). *RX Data* displays the amount in *Human Readable* format – up to three decimal places in one of these units of measurement: megabytes (MB), kilobytes (kB), gigabytes (GB), or terabytes (TB).

**RX Packets** Displays the number of packets received without errors.

**RX Errors** Displays the number of packets received with errors.

**TX Bytes/Data** Displays the amount of data transmitted. *TX Bytes* displays the amount in *Raw* format (actual number of bytes). *TX Data* displays the amount in *Human Readable* format – up to three decimal places in one of these units of measurement: megabytes (MB), kilobytes (kB), gigabytes (GB), or terabytes (TB).

**TX Packets** Displays the number of packets transmitted without errors.

**TX Errors** Displays the number of packets transmitted with errors.

**Reset Statistics** Click this button to clear the displayed statistics and reset them to zero.

## Total Throughput

By default, *Total Throughput* and *Data Distribution* are displayed.

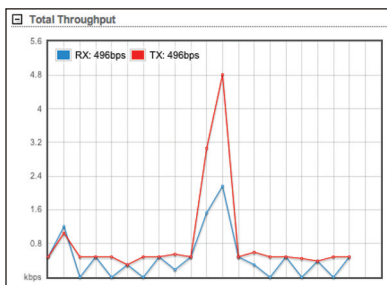

*Total Throughput* displays the current data traffic on the TOUGHSwitch in both graphical and numerical form. The chart scale and throughput dimension (bps, kbps, Mbps) change dynamically depending on the mean throughput value. The statistics are updated automatically.

## Data Distribution

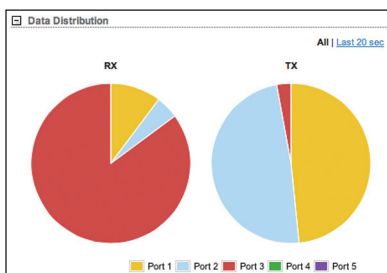

Two pie charts, *RX* and *TX*, display the data traffic allocated among the ports of the TOUGHSwitch. The pie charts are updated automatically.

**All/Last 20 sec** By default, the pie charts are displayed in *All* format, which is cumulative over time. To display data distribution for the last 20 seconds, click **Last 20 sec**.

## Details for Port

To display *Packet Distribution*, *Packet Rate*, and *Throughput* for a specific port, click the port on the image. The selected port is highlighted in blue.

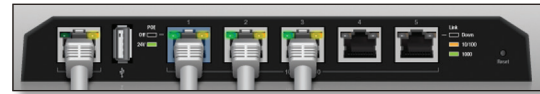

To return to the default view displaying *Total Throughput* and *Data Distribution*, click **Show Device Details**.

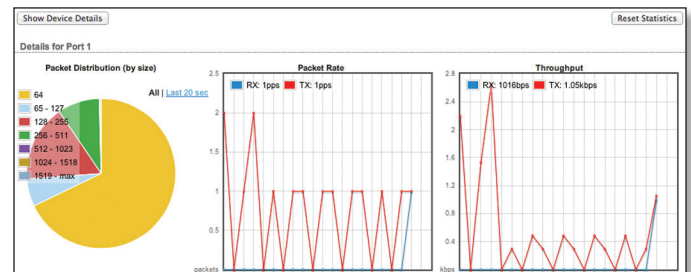

## Packet Distribution

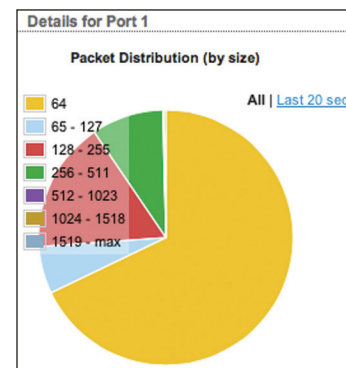

A pie chart, *Packet Distribution*, displays the current packet sizes going through the port. The pie chart is updated automatically.

 **Note:** The TOUGHSwitch PoE PRO does not display *Packet Distribution*.

**All/Last 20 sec** By default, the pie chart is displayed in *All* format, which is cumulative over time. To display packet distribution for the last 20 seconds, click **Last 20 sec**.

## Packet Rate

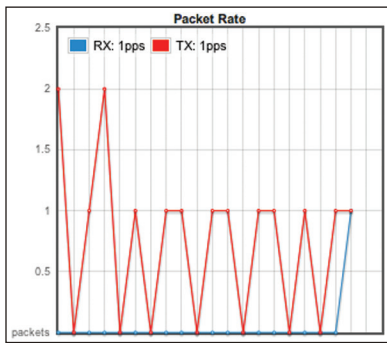

*Packet Rate* displays the current packets per second rate on the port in both graphical and numerical form. The chart scale and packet rate dimension change dynamically depending on the mean packet rate value. The statistics are updated automatically.

## Throughput

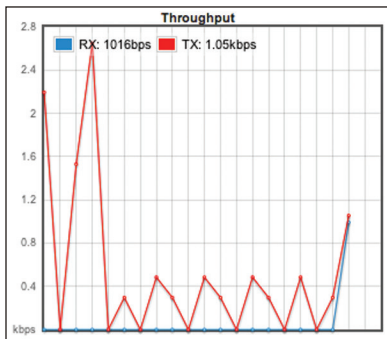

*Throughput* displays the current data traffic on the port in both graphical and numerical form. The chart scale and throughput dimension (bps, kbps, Mbps) change dynamically depending on the mean throughput value. The statistics are updated automatically.

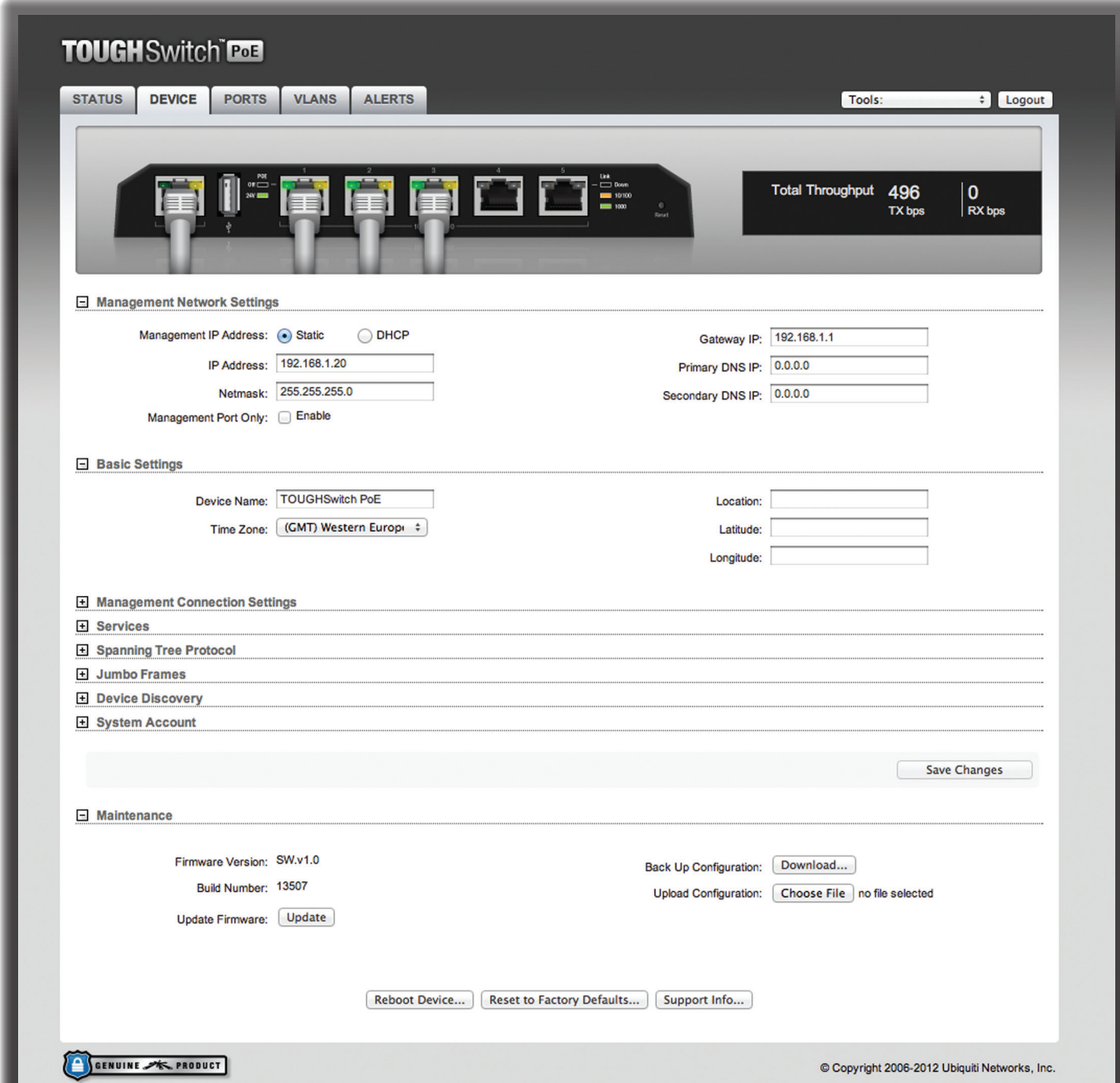

The screenshot displays the TOUGHSwitch PoE web interface. At the top, there are navigation tabs: STATUS, DEVICE (selected), PORTS, VLANS, and ALERTS. A 'Tools' dropdown and a 'Logout' button are also present. Below the navigation is a header image showing the physical switch with its ports and LEDs. To the right of this image, a black box displays 'Total Throughput' with '496 TX bps' and '0 RX bps'.

The main configuration area is divided into several sections:

- Management Network Settings:** Management IP Address is set to Static (192.168.1.20) with a Netmask of 255.255.255.0. Gateway IP is 192.168.1.1. Primary and Secondary DNS IP are both 0.0.0.0. Management Port Only is disabled.
- Basic Settings:** Device Name is TOUGHSwitch PoE. Time Zone is (GMT) Western Europe. Location, Latitude, and Longitude fields are empty.
- Management Connection Settings:** Services, Spanning Tree Protocol, Jumbo Frames, Device Discovery, and System Account are all listed with expandable options.
- Maintenance:** Firmware Version is SW.v1.0, Build Number is 13507, and Update Firmware has an 'Update' button. Back Up Configuration has a 'Download...' button. Upload Configuration has a 'Choose File' button and 'no file selected'.

At the bottom, there are buttons for 'Reboot Device...', 'Reset to Factory Defaults...', and 'Support Info...'. A 'Save Changes' button is located at the end of the configuration sections. The footer includes a 'GENUINE PRODUCT' logo and the copyright notice: © Copyright 2006-2012 Ubiquiti Networks, Inc.

## Chapter 5: Device Tab

The Device tab allows you to configure and use the Management Network Settings, Basic Settings, Management Connection Settings, Services, Spanning Tree Protocol, Jumbo Frames, Device Discovery, System Account, and Maintenance options for the TOUGHSwitch.

The TOUGHSwitch image displays the active LEDs and connections. See [“Hardware Overview” on page 1](#) for more information.

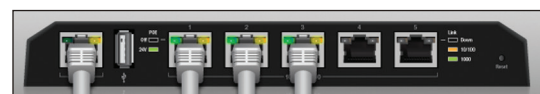

Total Throughput for TX and RX are also displayed.

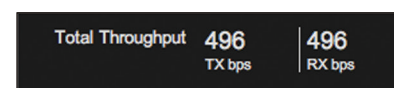



Place your mouse over a port to view its *PoE* status, *Speed* setting, duplex mode, and statistics for *TX* and *RX* throughput.

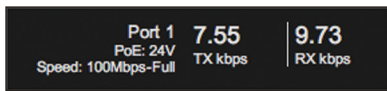

**Save Changes** To immediately save your changes, click **Save Changes**.

**Revert Changes** To cancel your changes, click **Revert Changes**.

## Management Network Settings

The *Management Network Settings* configure the IP settings and management access of the TOUGHSwitch.

Because the TOUGHSwitch is a Layer 2 device, the *IP Address* and *Netmask* are not mandatory; however, if you want to manage the TOUGHSwitch, then you will need to configure the *IP Address* and *Netmask* unless you select *DHCP*.

**Management IP Address** The TOUGHSwitch can use a static IP address or obtain an IP address from its DHCP server.

- **Static** Assign static IP settings to the TOUGHSwitch.



**Note:** IP settings should be consistent with the address space of the TOUGHSwitch's network segment.

- **IP Address** Specify the IP address of the TOUGHSwitch. This IP will be used for device management purposes. The default is *192.168.1.20*.
- **Netmask** When the netmask is expanded into its binary form, it provides a mapping to define which portions of the IP address range are used for the network devices and which portions are used for host devices. The netmask defines the address space of the TOUGHSwitch's network segment. The default *255.255.255.0* (or */24*) netmask is commonly used on many Class C IP networks.
- **Management Port Only** By default, this option is disabled and you can manage the TOUGHSwitch through any port. To restrict management access to only the *Management* port, check this box.



**Note:** The *Management Port Only* option must be disabled if you want traffic to flow between the *Management* port and numbered ports. Traffic will be limited to 10/100 Mbps and, under heavy load, may cause performance degradation of the TOUGHSwitch.

- **Gateway IP** Typically, this is the IP address of the host router, which provides the point of connection to the Internet. This can be a DSL modem, cable modem, or WISP gateway router. The TOUGHSwitch directs packets to the gateway if the destination host is not within the local network. The default is *192.168.1.1*.
- **Primary DNS IP** Specify the IP address of the primary DNS (Domain Name System) server.
- **Secondary DNS IP** Specify the IP address of the secondary DNS server. This entry is optional and used only if the primary DNS server is not responding.
- **DHCP** The local DHCP server assigns a dynamic IP address, netmask, gateway IP address, and DNS address to the TOUGHSwitch.



**Note:** We do not recommend the *DHCP* option. The IP address may change, and you will need to use the *Discovery* tool from another Ubiquiti device or computer to discover the IP address of the TOUGHSwitch. You can also reset the TOUGHSwitch to its factory default settings. (Press and hold the **Reset** button for more than 10 seconds.) Its default *IP Address* is reset to *192.168.1.20*.

- **DHCP Fallback IP** Specify the IP address the TOUGHSwitch should use if a DHCP server is not found. The default is *192.168.1.20*.
- **DHCP Fallback Netmask** Specify the netmask the TOUGHSwitch should use if a DHCP server is not found. The default is *255.255.255.0*.
- **Management Port Only** By default, this option is disabled and you can manage the TOUGHSwitch through any port. To restrict management access to only the *Management* port, check this box.



**Note:** The *Management Port Only* option must be disabled if you want traffic to flow between the *Management* port and numbered ports. Traffic will be limited to 10/100 Mbps and, under heavy load, may cause performance degradation of the TOUGHSwitch.

## Basic Settings

The *Basic Settings* configure the device, date, and location settings of the TOUGHSwitch.

The screenshot shows the 'Basic Settings' configuration page. It includes the following fields:

- Device Name: TOUGHSwitch PoE
- Time Zone: (GMT) Western Europe
- Location: (empty)
- Latitude: (empty)
- Longitude: (empty)

**Device Name** Specify the Device Name (host name), which is the system-wide device identifier. The SNMP agent reports it to authorized management stations. The *Device Name* will be used in popular router operating systems, registration screens, and discovery tools.

**Time Zone** Specify the time zone in relation to Greenwich Mean Time (GMT). The default is *(GMT) Western Europe*.

**Location** Enter a description of the device's location.

**Latitude** Enter the latitude of the device's location in decimal format, if available. Use a minus sign (-) to indicate a latitude south of the equator.

**Longitude** Enter the longitude of the device's location in decimal format, if available. Use a minus sign (-) to indicate a longitude west of the Prime Meridian.

## Management Connection Settings

The *Management Connection Settings* section configures system connection services: *Web Server*, *Telnet Server*, and *SSH Server*.

### Web Server

The screenshot shows the 'Web Server' configuration page with the following settings:

- Secure Connection (HTTPS):  Enable
- Secure Server Port: 443
- Server Port: 80
- Session Timeout: 15 minutes

The following *Web Server* parameters can be set:

**Secure Connection (HTTPS)** By default, the web server uses secure HTTPS mode.

- **Secure Server Port** If secure HTTPS mode is used, specify the TCP/IP port of the web server. The default is 443.

**Server Port** If HTTP mode is used, specify the TCP/IP port of the web server. The default is 80.

**Session Timeout** Specify the maximum timeout before the session expires. Once a session expires, you must log in again using the username and password. The default is 15 minutes.

### SSH Server

The screenshot shows the 'SSH Server' configuration page with the following settings:

- SSH Server:  Enable
- Server Port: 22
- Password Authentication:  Enable
- Authorized Keys: Edit...

The following *SSH Server* parameters can be set:

**SSH Server** SSH access to the device is enabled by default.

- **Server Port** Specify the TCP/IP port of the SSH server. The default is 22.
- **Password Authentication** By default, this option is enabled and you must authenticate using administrator credentials to grant SSH access to the device. If you disable this option, then an authorized key is required.
- **Authorized Keys** Click **Edit** to import a public key file for SSH access to the device instead of using an admin password.

The screenshot shows the 'SSH Authorized Keys' configuration page. It includes an 'Import Public Key File' section with a 'Choose File' button and an 'Import' button. Below this is a table with the following columns: Enabled, Type, Key, Comment, Action. At the bottom of the page are 'Save' and 'Close' buttons.

- **Choose File** Click **Choose File** to locate the new key file. Select the file and click **Open**.
- **Import** Imports the file for SSH access.
- **Enabled** Enables the specific key. All the added keys are saved in the system configuration file; however, only the enabled keys are active on the device.
- **Type** Displays the type of key.
- **Key** Displays the key.
- **Comment** You can enter a brief description of the key.
- **Action** You have the following options:
  - **Add** Adds a public key file.
  - **Edit** Makes changes to a public key file. Click **Save** to save your changes.
  - **Del** Deletes a public key file.
- **Save** Saves your changes.
- **Close** Discards your changes.

## Telnet Server

The following *Telnet Server* parameters can be set:

**Telnet Server** This option activates Telnet access to the device.

- **Server Port** Specify the TCP/IP port of the Telnet server. The default is 23.

## Services

The *Services* section configures system management services: *SNMP Agent*, *System Log*, *Dynamic DNS*, and *NTP Client*.

### SNMP Agent

Simple Network Monitor Protocol (SNMP) is an application layer protocol that facilitates the exchange of management information between network devices. Network administrators use SNMP to monitor network-attached devices for issues that warrant attention.

The device contains an SNMP agent, which does the following:

- Provides an interface for device monitoring using SNMP
- Communicates with SNMP management applications for network provisioning
- Allows network administrators to monitor network performance and troubleshoot network problems

For the purpose of equipment identification, configure the SNMP agent with contact and location information:

**SNMP Agent** Enables the SNMP agent.

- **SNMP Community** Specify the SNMP community string. It is required to authenticate access to Management Information Base (MIB) objects and functions as an embedded password. The device supports a read-only community string; authorized management stations have read access to all the objects in the MIB except the community strings, but do not have write access. The device supports SNMP v1. The default *SNMP Community* is *public*.
- **Contact** Specify the contact who should be notified in case of emergency.
- **Location** Specify the physical location of the device.

## Dynamic DNS

Domain Name System (DNS) translates domain names to IP addresses; Each DNS server on the Internet holds these mappings in its respective DNS database. Dynamic Domain Name System (DDNS) is a network service that notifies the DNS server in real time of any changes in the device's IP settings. Even if the device's IP address changes, you can still access the device through its domain name.

**Dynamic DNS** If enabled, the device allows communications with the DDNS server.

- **Host Name** Enter the host name of the DDNS server.
- **Username** Enter the username of the DDNS account.
- **Password** Enter the password of the DDNS account.
- **Show** Check the box to display the password characters.

## System Log

If you enable the *System Log*, the messages display on the *Alerts* tab; see [“System Log” on page 25](#).

**System Log** This option enables the registration routine of system log (syslog) messages. By default it is disabled.

- **Remote Log** Enables the syslog remote sending function. System log messages are sent to a remote server, which is specified in the following fields:
  - **Remote Log IP Address** The host IP address that receives syslog messages. Properly configure the remote host to receive syslog protocol messages.
  - **Remote Log Port** The TCP/IP port that receives syslog messages. 514 is the default port for the commonly used system message logging utilities.

Every logged message contains at least a system time and host name. Usually a specific service name that generates the system event is also specified within the message. Messages from different services have different contexts and different levels of detail. Usually error, warning, or informational system service messages are reported; however, more detailed debug level messages can also be reported. The more detailed the system messages reported, the greater the volume of log messages generated.

## NTP Client

Network Time Protocol (NTP) is a protocol for synchronizing the clocks of computer systems over packet-switched, variable-latency data networks. You can use it to set the system time on the device. If the *System Log* option is enabled, then the system time is reported next to every log entry that registers a system event.

**NTP Client** If enabled, the device obtains the system time from a time server on the Internet.

- **NTP Server** Specify the IP address or domain name of the NTP server. The default is *0.ubnt.pool.ntp.org*.

## Spanning Tree Protocol

For optimal performance, there should be a single active path between two networking devices in an Ethernet network. Spanning Tree Protocol (STP) provides redundant paths and prevents network loops that can create excessive traffic and slow down performance. STP calculates the best path for network traffic; if the best path fails, STP recalculates and finds the next best path.

**Status** Enabled by default, STP provides redundancy without network loops.

**Version** Select the version of STP to use. STP and Rapid STP (RSTP) display the following states: *Blocking*, *Learning*, and *Forwarding*. RSTP is recommended because ports can more quickly progress to the forwarding state. When STP is selected, the TOUGHSwitch sends STP packets. The default is *RSTP*.

**Max Age** Specify how long the TOUGHSwitch saves a configuration message received on a port. If the TOUGHSwitch does not hear any new configuration messages after the *Max Age* time interval, then the TOUGHSwitch adapts and starts to reconfigure. The default is 20 seconds.

**Hello Time** Specify the time interval between configuration messages transmitted by the TOUGHSwitch to other switches. The default is 2 seconds.

**Forward Delay** Specify how long the listening and learning states last before the TOUGHSwitch forwards traffic. The default is 15 seconds.

**Priority** STP uses priority values to select a switch as the root switch of the spanning tree. Specify the *Priority* value of the TOUGHSwitch. The default is 32768.

## Jumbo Frames

The Maximum Transmission Unit (MTU) is the maximum packet size (in bytes) that a network interface can transmit. A jumbo frame is a frame that is larger than the standard Ethernet frame with an MTU of 1500. Jumbo frames are typically used for Gigabit Ethernet connections.

**Jumbo Frames** By default, this option is disabled; the TOUGHSwitch does not handle jumbo frames and drops them. If you enable this option, the TOUGHSwitch handles jumbo frames and forwards them. The maximum *MTU* of the TOUGHSwitch PoE is 9216, and the maximum *MTU* of the TOUGHSwitch PoE PRO is 9720.

## Device Discovery

**Discovery** This option is enabled by default, so the device can be discovered by other Ubiquiti devices through the *Device Discovery* tool. See **“Discovery” on page 27** for more information.

## System Accounts

You can change the administrator password to protect your device from unauthorized changes. We recommend that you change the default administrator password during the very first system setup:

**Administrator Username** Specify the name of the administrator.

**Key button** Click this button to change the password.

- **Current Password** Enter the current password for the administrator account. It is required to change the *Password* or *Administrator Username*.
- **New Password** Enter the new password for the administrator account.
- **Verify New Password** Re-enter the new password for the administrator account.



**Note:** The password length is 8 characters maximum; passwords exceeding 8 characters will be truncated.

## Maintenance

The controls in this section manage the device maintenance routines: firmware, configuration, reboot, reset to factory defaults, and support information reports.



**Firmware Version** Displays the current firmware version.

**Build Number** Displays the build number of the firmware version.

**Update Firmware** To update the TOUGHSwitch with new firmware, click **Update**.

The TOUGHSwitch firmware update is compatible with all configuration settings. The system configuration is preserved while the TOUGHSwitch is updated with a new firmware version. However, we recommend that you click **Download** to back up your current system configuration before updating the firmware.

Updating the firmware is a three-step procedure:

1. Click **Choose File** to locate the new firmware file. Select the file and click **Open**.
2. Click **Upload** to upload the new firmware to the TOUGHSwitch.
3. The *Uploaded Firmware Version* is displayed. Click **Update** to confirm.

If the firmware update is in process, you can close the firmware update window, but this does not cancel the firmware update. Please be patient, as the firmware update routine can take three to seven minutes. You cannot access the TOUGHSwitch until the firmware update routine is completed.



**WARNING:** Do not power off, do not reboot, and do not disconnect the TOUGHSwitch from the power supply during the firmware update process as these actions will damage the TOUGHSwitch!

**Back Up Configuration** The TOUGHSwitch configuration is stored in a plain text file (.cfg file). Click **Download** to download the current system configuration file.



**Note:** We strongly recommend that you save the configuration file in a secure location. The configuration file includes confidential information, such as hashed passwords.

**Upload Configuration** Click **Choose File** to locate the new configuration file. Select the file and click **Open**. We recommend that you back up your current system configuration before uploading the new configuration.

- **Upload** Click this button to upload the new configuration file to the TOUGHSwitch. Click **Apply** to confirm.

After the TOUGHSwitch reboots, the settings of the new configuration are displayed in the Configuration Interface.

**Reboot Device** Initiates a full reboot cycle of the device. Reboot is the same as the hardware reboot, which is similar to the power-off and power-on cycle. The system configuration stays the same after the reboot cycle completes. Any changes that have not been applied are lost.

**Reset to Factory Defaults** Resets the TOUGHSwitch to the factory default settings. This option will reboot the TOUGHSwitch, and all factory default settings will be restored. We recommend that you back up your current system configuration before resetting the TOUGHSwitch to its defaults.

**Support Info** This generates a support information file that the Ubiquiti support engineers can use when providing customer support. This file only needs to be generated at their request.

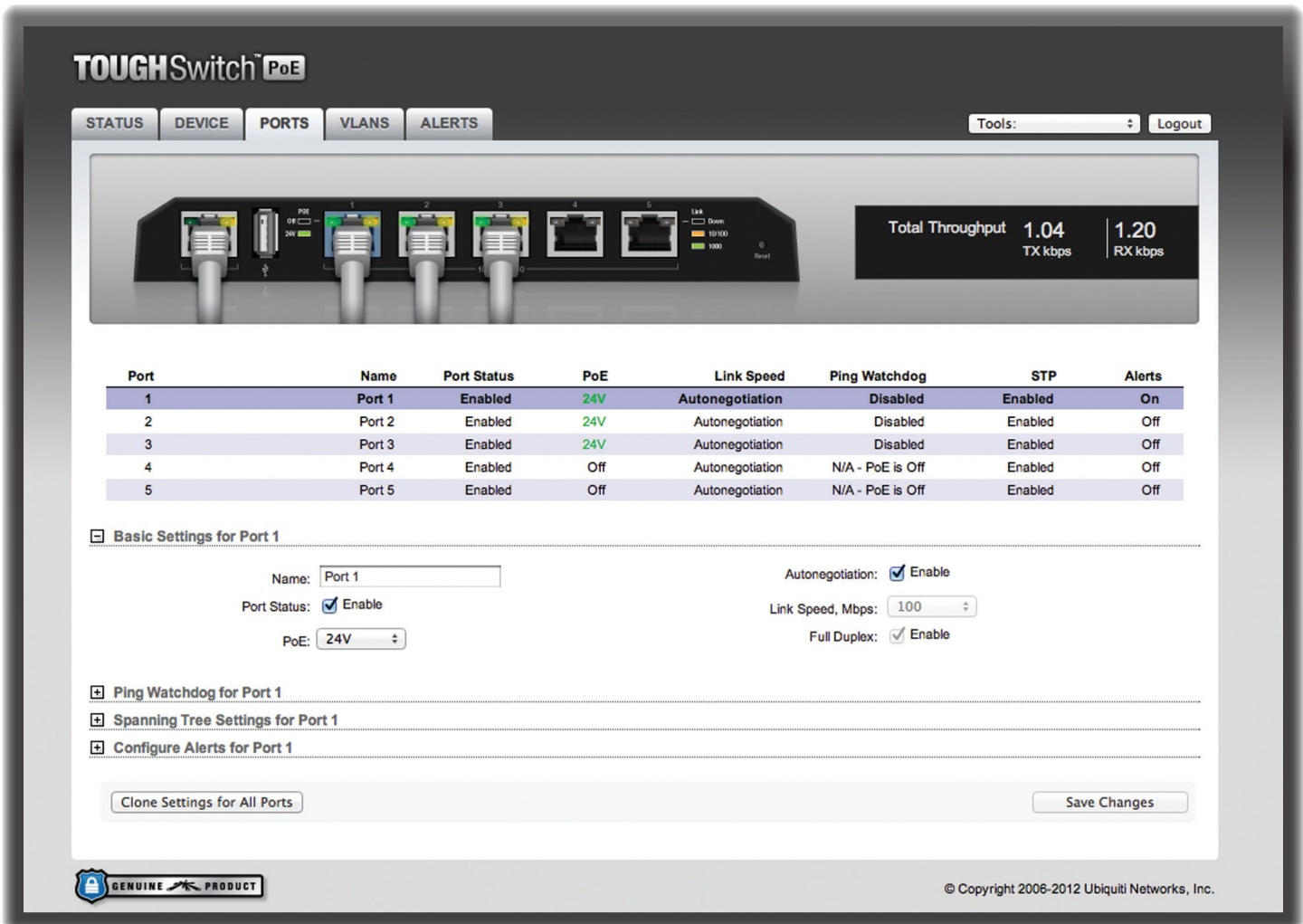

## Chapter 6: Ports Tab

The *Ports* tab allows you to configure the *Basic Settings*, *Ping Watchdog* settings, and alerts for each port of the TOUGHSwitch.

The TOUGHSwitch image displays the active LEDs and connections. See **“Hardware Overview” on page 1** for more information. To change a port’s settings, click the port on the image. Then the port is highlighted in blue.



Total Throughput for TX and RX are also displayed.

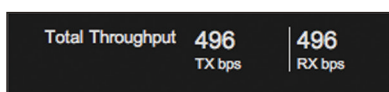

Place your mouse over a port to view its *PoE* status, *Speed* setting, duplex mode, and statistics for TX and RX throughput.

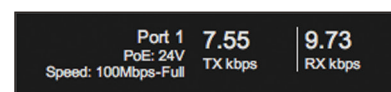

For each port, the *Ports* tab displays its *Port* number, *Name*, *Status*, *PoE* status, *Link Speed*, *Ping Watchdog*, *STP* status (if enabled on the *Device* tab), and *Alerts* status. To sort the ports in a specific order, click the appropriate column head.

Port	Name	Port Status	PoE	Link Speed	Ping Watchdog	STP	Alerts
1	Port 1	Enabled	24V	Autonegotiation	Disabled	Enabled	On
2	Port 2	Enabled	24V	Autonegotiation	Disabled	Enabled	Off
3	Port 3	Enabled	24V	Autonegotiation	Disabled	Enabled	Off
4	Port 4	Enabled	Off	Autonegotiation	N/A - PoE is Off	Enabled	Off
5	Port 5	Enabled	Off	Autonegotiation	N/A - PoE is Off	Enabled	Off

**Save Changes** To immediately save your changes, click **Save Changes**.

**Clone Settings for All Ports** After you have made changes for the selected port, click this button to apply the same changes to all ports. Then click **Save Changes**.

**WARNING:** The *PoE* setting is also cloned. Ensure that the same *PoE* setting suits all ports before you clone the settings of the selected port.

## Basic Settings for Port



**Name** Enter a name for the port.

**Port Status** To use this port, check the box.



**Note:** If you disable a port, its *PoE* functionality remains.

**PoE** PoE is disabled by default on all ports. To output PoE to the connected device, select **24V** or **48V** (48V available only on the TOUGHSwitch PoE PRO). To disable PoE, select **Off**.



**Note:** Before enabling PoE, check the specifications of your airMAX, UniFi, legacy, or third-party devices to ensure they support passive PoE and require the available amount of voltage. The TOUGHSwitch PoE offers 24V passive PoE, and the TOUGHSwitch PoE PRO offers 24V or 48V passive PoE.

**Autonegotiation** By default, *Autonegotiation* is enabled. The TOUGHSwitch automatically negotiates transmission parameters, such as speed and duplex, with its counterpart. In this process, the networked devices first share their capabilities and then choose the fastest transmission mode they both support.



**Note:** *Autonegotiation* applies only to speed and duplex, not POE.

**Link Speed, Mbps** This is the speed of the port. To manually specify the maximum transmission link speed, select **100** or **10**. To achieve full performance with extra-long Ethernet cables, ensure that you use CAT6-qualified cables and interconnects.

**Full Duplex** By default, *Full Duplex* is enabled. Full-duplex mode allows communication in both directions simultaneously. Half-duplex mode allows communication in one direction at a time, alternating between transmission and reception.

## Ping Watchdog for Port

*Ping Watchdog* is only for PoE-enabled ports. It configures the device to continuously ping a user-defined IP address (it can be the Internet gateway, for example). If it is unable to ping under the user-defined constraints, then the device will automatically turn off PoE on the port, and then turn it back on. This option creates a kind of “fail-proof” mechanism.

*Ping Watchdog* is dedicated to continuous monitoring of the specific connection to the remote host using the *Ping* tool. The *Ping* tool works by sending ICMP echo request packets to the target host and listening for ICMP echo response replies. If the specified number of replies is not received, the tool reboots the device.



**Port Ping Watchdog** Enables use of Ping Watchdog.

- **IP Address To Ping** Specify the IP address of the target host to be monitored by *Ping Watchdog*.
- **Ping Interval** Specify the time interval (in seconds) between the ICMP echo requests that are sent by *Ping Watchdog*. The default value is 300 seconds.
- **Startup Delay** Specify the initial time delay (in seconds) until the first ICMP echo requests are sent by *Ping Watchdog*. The default value is 300 seconds. The *Startup Delay* value should be at least 60 seconds as the network interface and wireless connection initialization takes a considerable amount of time if the device is rebooted.
- **Failure Count** Specify the number of ICMP echo response replies. If the specified number of ICMP echo response packets is not received continuously, *Ping Watchdog* will reboot the device. The default value is 3.
- **Cut Power for** Specify the number of seconds this port should pause PoE (if applicable).



**WARNING:** Cutting power during a firmware upgrade can damage your device. Ensure that you specify a safe *Ping Interval*.

## Spanning Tree Settings for Port

STP settings are available per port if STP is enabled on the *Device* tab (see **“Spanning Tree Protocol” on page 17**).

**Edge Port** If enabled, designates this port as a port that connects to only a host device. The host device must not be connected to another switch or router. The *Edge Port* is always in the forwarding state and never undergoes the learning or blocking state.



**Note:** Ensure that the *Edge Port* is connected to only a host device. If the *Edge Port* is connected to a switch or router (even indirectly through a host device), then this may cause a network loop.

**Path Cost** The lower the value, the better. STP uses the *Path Cost* to determine the best path between devices. In most cases, specify lower values for ports with higher bandwidths, such as gigabit speeds, and specify higher values for ports with lower bandwidth. You can also specify lower values for ports you prefer to use. (*Path Cost* supersedes *Priority*.) The default is *0*.

**Priority** The lower the value, the better. STP uses the *Priority* as a tiebreaker. If the *Path Cost* of multiple ports are the same, then STP chooses the port with the highest *Priority* (lowest value) as the active port (the others are blocked). If STP detects a network loop, then a port with higher *Priority* is less likely to be blocked. If multiple ports share the highest *Priority*, then STP enables the port with the lowest port ID. The *Priority* range is 0 (highest priority) to 255 (lowest priority). The default is *128*.

## Configure Alerts for Port

If you configure alerts, the alerts display on the *Alerts* tab; see **“Alert Log” on page 24**.

For each port, you can configure the following alerts:

**Link Goes Up/Down** Generates an alert when the link goes up or down.

**RX Bandwidth Goes Above** Generates an alert when the RX bandwidth exceeds the specified maximum. Enter the maximum in Mbps.

**RX Bandwidth Goes Below** Generates an alert when the RX bandwidth drops below the specified minimum. Enter the minimum in Mbps.

**TX Bandwidth Goes Above** Generates an alert when the TX bandwidth exceeds the specified maximum. Enter the maximum in Mbps.

**TX Bandwidth Goes Below** Generates an alert when the RX bandwidth drops below the specified minimum. Enter the minimum in Mbps.



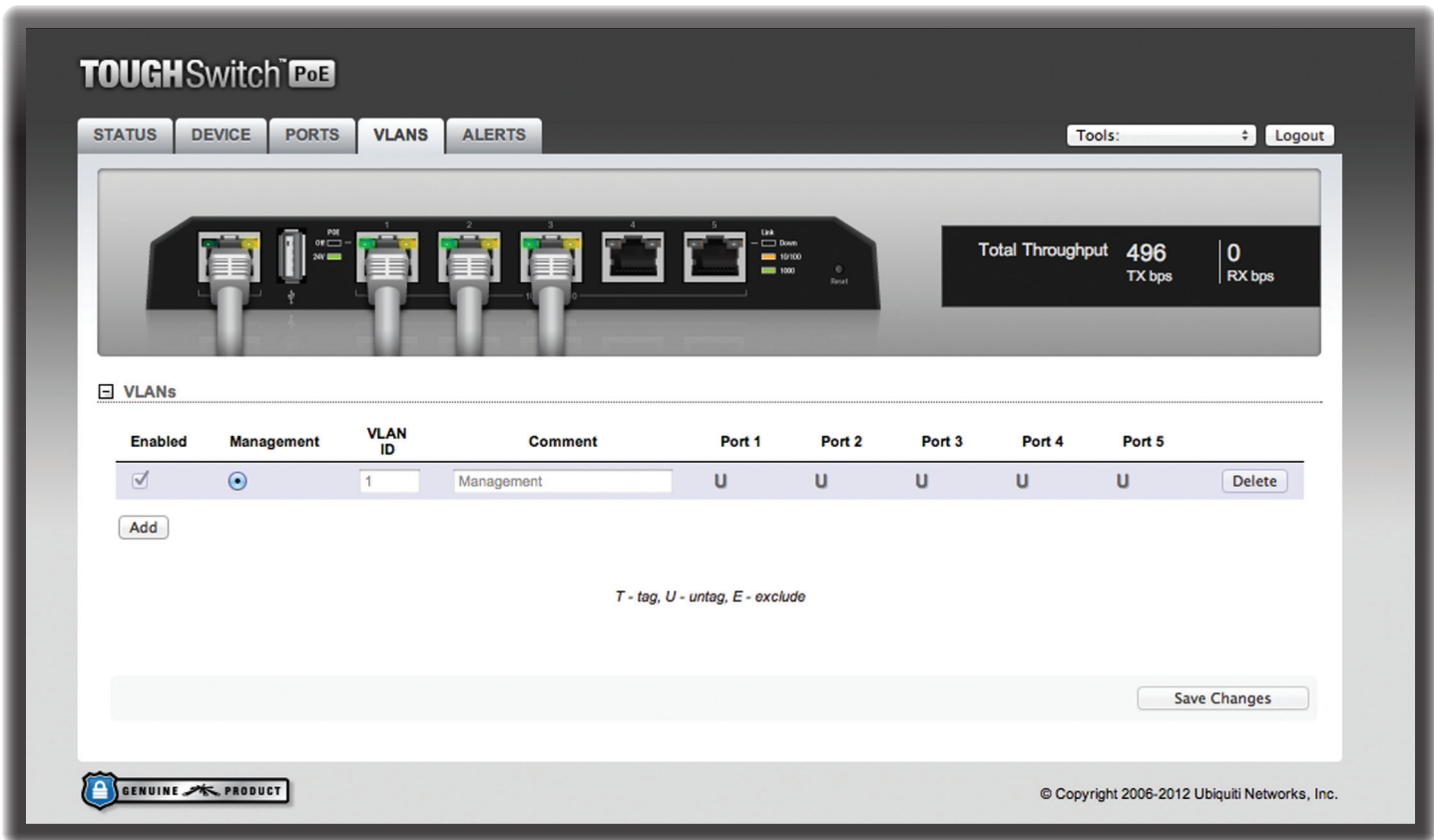

## Chapter 7: VLANs Tab

The *VLANs* tab configures Virtual Local Area Networks (VLANs), so you can assign ports to various VLANs for more convenient switching.

The TOUGHSwitch image displays the active LEDs and connections. See **“Hardware Overview” on page 1** for more information.

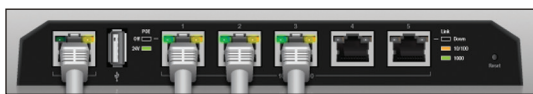

Total Throughput for TX and RX are also displayed.

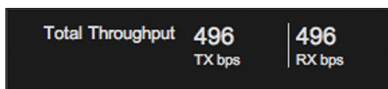

Place your mouse over a port to view its PoE status, Speed setting, duplex mode, and statistics for TX and RX throughput.

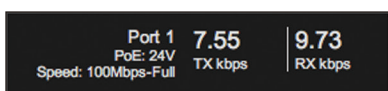

**Save Changes** To immediately save your changes, click **Save Changes**.

**Revert Changes** To cancel your changes, click **Revert Changes**.

## VLANs

All ports belong to VLAN1, which is enabled as a management VLAN by default. A port can belong to more than one VLAN.

**Add** Create a new Virtual Local Area Network (VLAN).

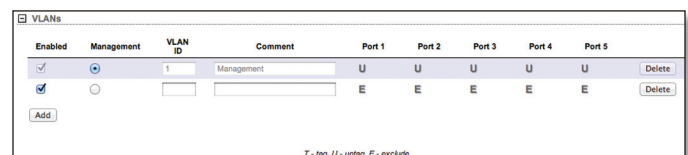

- **Enabled** Check the box to enable the VLAN.
- **Management** Create the VLAN before you select this option. Ensure that you have access via the new VLAN before you choose to manage through this VLAN.
  -  **Note:** If you configure a new VLAN as *Management*, then VLAN 1 is no longer the management VLAN. If you cannot access the new management VLAN, then you are locked out of the Configuration Interface. (If you are locked out, you can reset the TOUGHSwitch to its factory defaults.)
- **VLAN ID** Enter a unique VLAN ID from 2 to 4095.
- **Comment** Enter a description of this VLAN.

- **Port** \_ For each port, assign its membership status as a tagged or untagged member of this VLAN. You can also exclude a port from this VLAN.
  - **T (tag)** The port belongs to this VLAN, and VLAN tags are included on outgoing frames. Click the letter until it becomes a “T”.
  - **U (untag)** The port belongs to this VLAN, and VLAN tags are excluded from outgoing frames. Click the letter until it becomes a “U”.
  - **E (exclude)** The port does not belong to this VLAN. Click the letter until it becomes a “E”.
- **Delete** Permanently removes the VLAN. If you want to temporarily disable the VLAN, remove the check from the *Enabled* box.

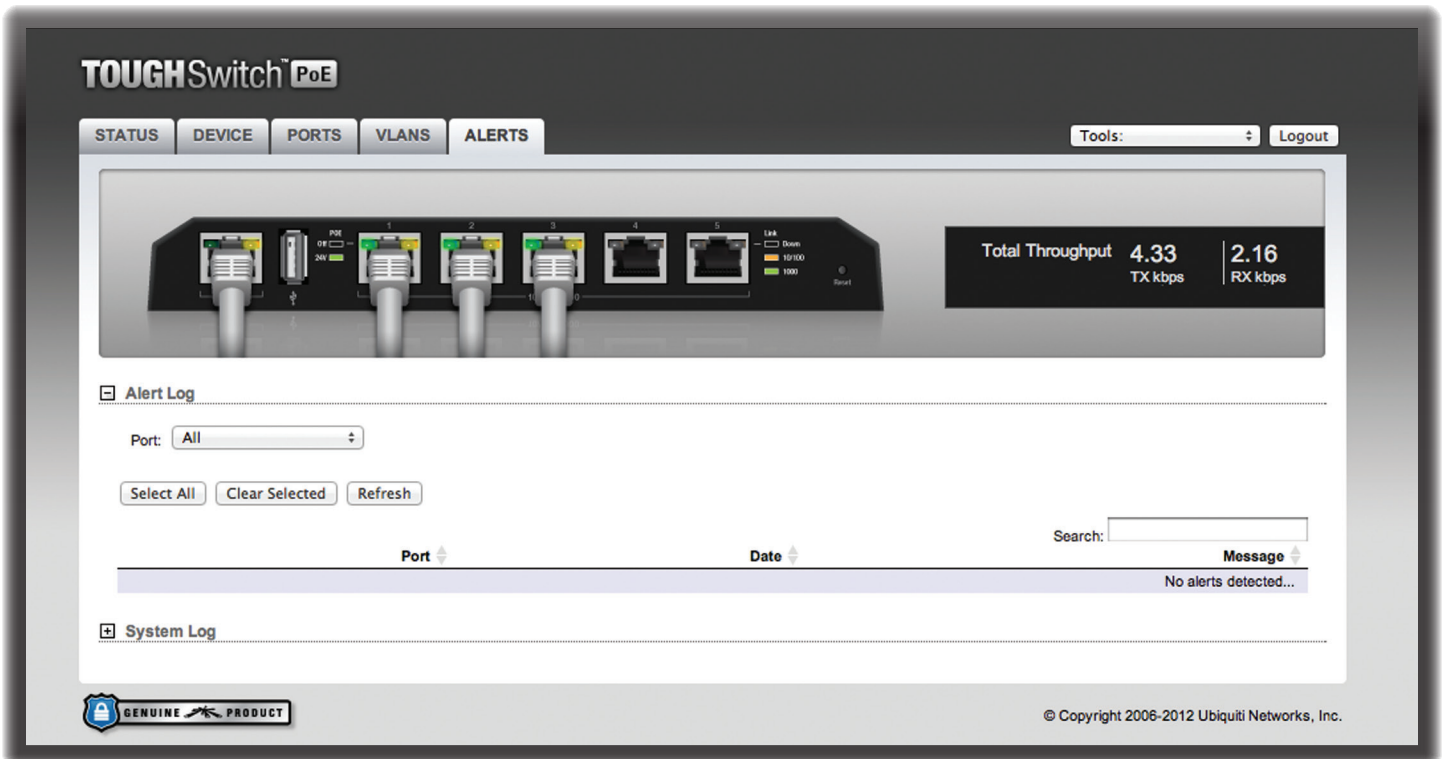

## Chapter 8: Alerts Tab

The *Alerts* tab displays logs registering alerts or system events.

The TOUGHSwitch image displays the active LEDs and connections. See [“Hardware Overview” on page 1](#) for more information.



Total Throughput for TX and RX are also displayed.



Place your mouse over a port to view its PoE status, Speed setting, duplex mode, and statistics for TX and RX throughput.

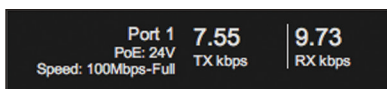

## Alert Log

When alerts logging is configured on the *Ports* tab (see [“Configure Alerts for Port” on page 21](#)), the *Alert Log* lists all alerts. By default, alert logging is disabled.

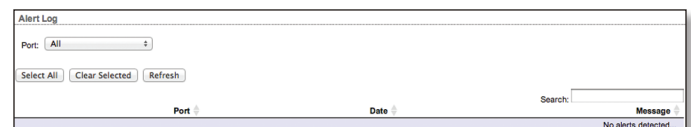

**Port** To display entries for all ports, select **All**. To display entries for a specific port, select the port number from the drop-down list.

When alerts logging is enabled, the *Select All* and *Clear Selected* buttons are available:

**Select All** To select all entries in the *Alert Log*, click **Select All**.

**Clear Selected** To delete specific entries in the *Alert Log*, select those entries and then click **Clear**.

**Refresh** To update the log content, click **Refresh**.

**Search** Allows you to search for specific text. Begin typing; there is no need to press **enter**. The results are filtered in real time as soon as you type two or more characters.

Entries in the *Alert Log* include the *Port* number, *Date*, and *Message*.

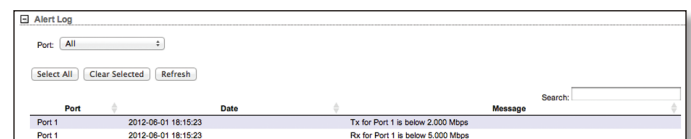

## System Log

When system logging is enabled on the *Device* tab (see **“System Log” on page 16**), the *System Log* lists all system events. By default, system logging is disabled.

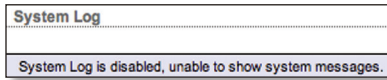

When system logging is enabled, there are two buttons available:

**Clear** To delete all entries in the *System Log*, click **Clear**.

**Refresh** To update the log content, click **Refresh**.

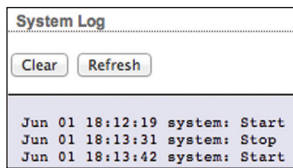

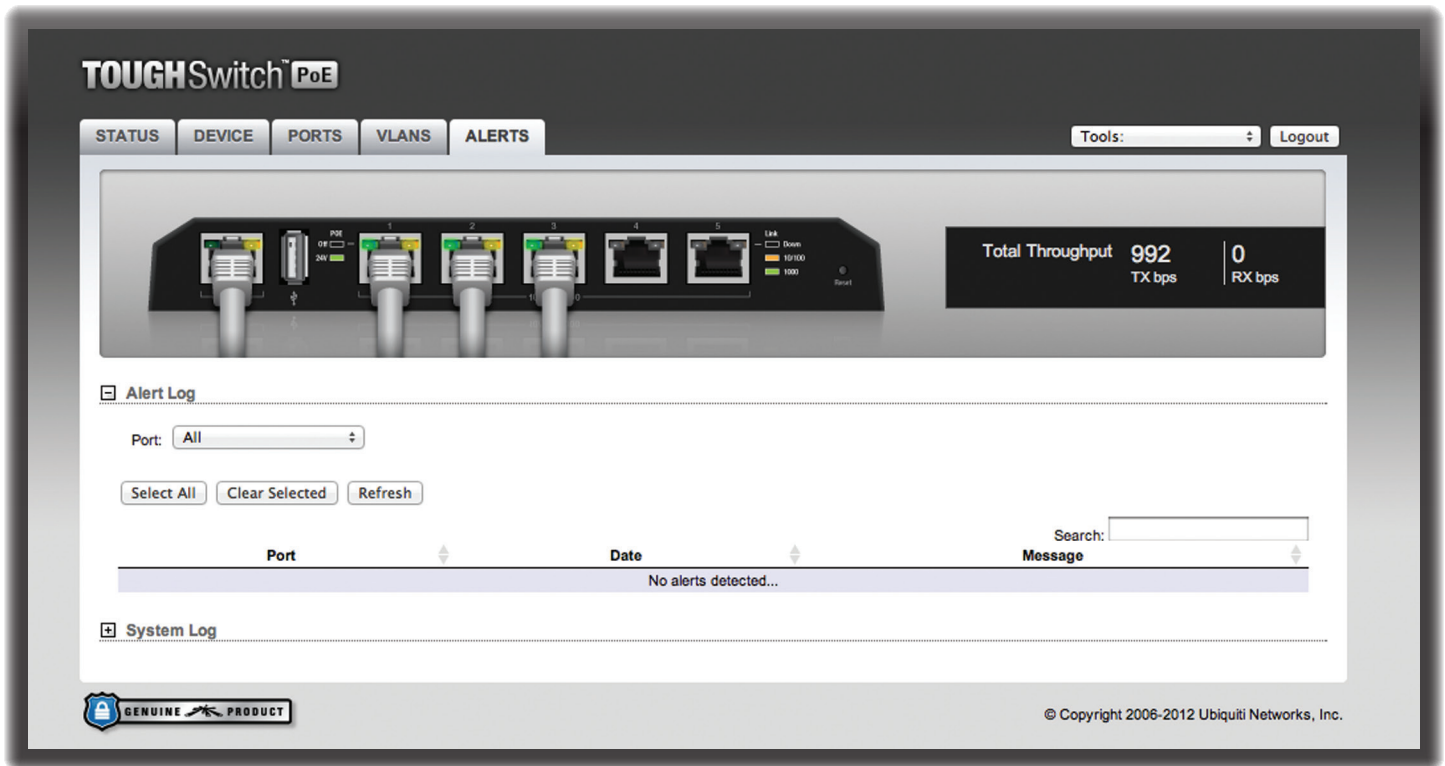

## Chapter 9: Tools

Each tab of the Configuration Interface contains network administration and monitoring tools. Click the **Tools** drop-down list at the top right corner of the page.

### Ping

You can ping other devices on the network directly from the TOUGHSwitch. The *Ping* tool uses ICMP packets to check the preliminary link quality and packet latency estimation between two network devices.

**Network Ping**

Select Destination IP: or specify manually

Packet Count:

Packet Size:

Host	Time	TTL

0 of 0 packets received, 0% loss

Min: 0 ms      Avg: 0 ms      Max: 0 ms

### Network Ping

**Select Destination IP** You have two options:

- Select a remote system IP from the drop-down list, which is generated automatically.
- Select **or specify manually** and enter the IP address in the field displayed below.

**Packet Count** Specify the number of packets to send for the ping test. The default is 5.

**Packet Size** Specify the size of the packet in bytes. The default is 56.

**Start** Click this button to start the test.

Packet loss statistics and latency time evaluation are displayed after the test is completed.

## Traceroute

The *Traceroute* tool traces the hops from the TOUGHSwitch to a specified outgoing IP address. Use this tool to find the route taken by ICMP packets across the network to the destination host.

The screenshot shows the 'Network Traceroute' interface. At the top, there is a 'Destination Host' input field and a 'Resolve IP Addresses' checkbox. Below this is a table with four columns: '#', 'Host', 'IP', and 'Responses'. The table is currently empty. At the bottom right of the interface is a 'Start' button.

**Destination Host** Enter the IP address of the destination host.

**Resolve IP Addresses** Select this option to resolve the IP addresses symbolically rather than numerically.

**Start** Click this button to start the test.

Responses are displayed after the test is completed.

## Discovery

The *Device Discovery* tool searches for all Ubiquiti devices on your network, specifically the subnet that the TOUGHSwitch belongs to. The *Search* field automatically filters devices containing specified names or numbers as you enter them.

The screenshot shows the 'Device Discovery' interface. It features a search field at the top right. Below it is a table with the following columns: MAC Address, Device Name, Mode, SSID, Product, Firmware, and IP Address. The table contains four entries:

MAC Address	Device Name	Mode	SSID	Product	Firmware	IP Address
00:15:6D:F0:CA:CD	Rocket M5	STA	ubnt	Rocket M5	v5.5	192.168.1.50
00:27:22:04:35:C3	Rocket M5 GPS	AP	ubnt	Rocket M5 GPS	v5.5.1-beta2	192.168.1.30
00:27:22:04:35:B9	Rocket M5 GPS	AP	ubnt	Rocket M5 GPS	v5.5.1-beta	192.168.1.40
00:27:22:76:C8:4C	TOUGHSwitch PoE	-	-	TOUGHSwitch PoE	v1.0	192.168.1.20

Below the table, it says 'Showing 1 to 4 of 4 entries' with navigation arrows. A 'Scan' button is located at the bottom right.

The *Device Discovery* tool reports the *MAC Address*, *Device Name*, wireless *Mode* (if applicable), *SSID*, *Product* type, *Firmware* version, and *IP Address* for each Ubiquiti device. To access a device configuration through its web management interface, click the device's IP address.

To refresh the window, click **Scan**.

## Appendix A: Specifications

5-Port TOUGHSwitch PoE	
Dimensions	197 x 87.5 x 27.3 mm
Weight	250 g
Power Input	24VDC, 2.5A Power Adapter (Included)
Max. Power Consumption	60 W
PoE Out Voltage Range	22-24VDC
Max. PoE Wattage Per Data Port	18 W
ESD Rating	24 kV Air / 24 kV Contact
PoE Method	Passive
Button	Reset
USB Port	2.0 Type A (Reserved for Future Use)
Processor	MIPS 24K, 400 MHz
System Memory	64 MB
Code Storage	8 MB
Certifications	CE, FCC, IC
Wall-Mount	Yes
Operating Temperature	-25 to 55°C (-13 to 131° F)
Operating Humidity	90% Non-Condensing
PoE Configurable Per Port	
Management	N/A
Data Ports	Off/24V
LEDs Per Port	
Management	Power/Link
Data Ports	PoE, Speed/Link/Activity
Networking Interfaces	
Management Port	(1) 10/100 Ethernet Port
Data Ports	(5) 10/100/1000 Ethernet Ports

8-Port TOUGHSwitch PoE PRO	
Dimensions	210 x 185 x 41 mm
Weight	1.24 kg
Power Input	110-120VAC / 210-230VAC
Max. Power Consumption	150 W
PoE Out Voltage Range	45-48VDC / 22-24VDC
Max. PoE Wattage Per Data Port	18W
ESD Rating	24 kV Air / 24 kV Contact
PoE Method	Passive
Button	Reset
USB Port	2.0 Type A (Reserved for Future Use)
Processor	MIPS 24K, 400 MHz
System Memory	64 MB
Code Storage	8 MB
Certifications	CE, FCC, IC
Operating Temperature	-25 to 55°C (-13 to 131° F)
Operating Humidity	90% Non-Condensing
PoE Configurable Per Port	
Management	N/A
Data Ports	Off/24V/48V
LEDs Per Port	
Management	Power/Link
Data Ports	PoE, Speed/Link/Activity
Networking Interfaces	
Management Port	(1) 10/100 Ethernet Port
Data Ports	(8) 10/100/1000 Ethernet Ports



## Appendix B: Safety Notices

1. Read, follow, and keep these instructions.
2. Heed all warnings.
3. Only use attachments/accessories specified by the manufacturer.

 **WARNING:** Do not use this product in location that can be submerged by water.

 **WARNING:** Avoid using this product during an electrical storm. There may be a remote risk of electric shock from lightning.

### Electrical Safety Information

1. Compliance is required with respect to voltage, frequency, and current requirements indicated on the manufacturer's label. Connection to a different power source than those specified may result in improper operation, damage to the equipment or pose a fire hazard if the limitations are not followed.
2. There are no operator serviceable parts inside this equipment. Service should be provided only by a qualified service technician.
3. This equipment is provided with a detachable power cord which has an integral safety ground wire intended for connection to a grounded safety outlet.
  - a. Do not substitute the power cord with one that is not the provided approved type. Never use an adapter plug to connect to a 2-wire outlet as this will defeat the continuity of the grounding wire.
  - b. The equipment requires the use of the ground wire as a part of the safety certification, modification or misuse can provide a shock hazard that can result in serious injury or death.
  - c. Contact a qualified electrician or the manufacturer if there are questions about the installation prior to connecting the equipment.
  - d. Protective earthing is provided by Listed AC adapter. Building installation shall provide appropriate short-circuit backup protection.
  - e. Protective bonding must be installed in accordance with local national wiring rules and regulations.

## Appendix C: Warranty

### General Warranty

UBIQUITI NETWORKS, Inc (“UBIQUITI NETWORKS”) represents and warrants that the Products furnished hereunder shall be free from defects in material and workmanship for a period of one (1) year from the date of shipment by UBIQUITI NETWORKS under normal use and operation. UBIQUITI NETWORKS sole and exclusive obligation under the foregoing warranty shall be to repair or replace, at its option, any defective Product that fails during the warranty period. The expense of removal and reinstallation of any item is not included in this warranty.

The foregoing warranty is exclusive and in lieu of all other warranties, express or implied, including the implied warranties of merchantability and fitness for a particular purpose and any warranties arising from a course of dealing, usage or trade practice with respect to the products. Repair or replacement in the manner provided herein shall be the sole and exclusive remedy of Buyer for breach of warranty and shall constitute fulfillment of all liabilities of UBIQUITI NETWORKS with respect to the quality and performance of the Products. UBIQUITI NETWORKS reserves the right to inspect all defective Products (which must be returned by Buyer to UBIQUITI NETWORKS factory freight prepaid).

No Products will be accepted for replacement or repair without obtaining a Return Materials Authorization (RMA) number from UBIQUITI NETWORKS. Products returned without an RMA number will not be processed and will be returned to Buyer freight collect. UBIQUITI NETWORKS shall have no obligation to make repairs or replacement necessitated by catastrophe, fault, negligence, misuse, abuse, or accident by Buyer, Buyer’s customers or any other parties. The warranty period of any repaired or replaced. Product shall not extend beyond its original term.

### Warranty Conditions

The foregoing warranty shall apply only if:

- (I) The Product has not been subjected to misuse, neglect or unusual physical, electrical or electromagnetic stress, or some other type of accident.
- (II) No modification, alteration or addition has been made to the Product by persons other than UBIQUITI NETWORKS or UBIQUITI NETWORKS’ authorized representatives or otherwise approved by UBIQUITI NETWORKS.
- (III) The Product has been properly installed and used at all times in accordance, and in all material respects, with the applicable Product documentation.
- (IV) All Ethernet cabling runs use CAT5 (or above) shielded cabling.

### Disclaimer

UBIQUITI NETWORKS does not warrant that the operation of the products is error-free or that operation will be uninterrupted. In no event shall UBIQUITI NETWORKS be responsible for damages or claims of any nature or description relating to system performance, including coverage, buyer’s selection of products for buyer’s application and/or failure of products to meet government or regulatory requirements.

### Returns

In the unlikely event a defect occurs, please work through the dealer or distributor from which this product was purchased.

## Appendix D: Compliance Information

### FCC

Changes or modifications not expressly approved by the party responsible for compliance could void the user's authority to operate the equipment.

This device complies with Part 15 of the FCC Rules. Operation is subject to the following two conditions:

1. This device may not cause harmful interference, and
2. This device must accept any interference received, including interference that may cause undesired operation.

NOTE: This equipment has been tested and found to comply with the limits for a Class A digital device, pursuant to part 15 of the FCC Rules. These limits are designed to provide reasonable protection against harmful interference when the equipment is operated in a commercial environment. This equipment generates, uses, and can radiate radio frequency energy and, if not installed and used in accordance with the instruction manual, may cause harmful interference to radio communications. Operations of this equipment in a residential area is likely to cause harmful interference in which case the user will be required to correct the interference at his own expense.

### Industry Canada

This Class A digital apparatus complies with Canadian ICES-003.

Cet appareil numérique de la classe A est conforme à la norme NMB-003 Canada.

### CE Marking

CE marking on this product represents the product is in compliance with all directives that are applicable to it.

## RoHS/WEEE Compliance Statement



### English

European Directive 2002/96/EC requires that the equipment bearing this symbol on the product and/or its packaging must not be disposed of with unsorted municipal waste. The symbol indicates that this product should be disposed of separately from regular household waste streams. It is your responsibility to dispose of this and other electric and electronic equipment via designated collection facilities appointed by the government or local authorities. Correct disposal and recycling will help prevent potential negative consequences to the environment and human health. For more detailed information about the disposal of your old equipment, please contact your local authorities, waste disposal service, or the shop where you purchased the product.

### Deutsch

Die Europäische Richtlinie 2002/96/EC verlangt, dass technische Ausrüstung, die direkt am Gerät und/oder an der Verpackung mit diesem Symbol versehen ist, nicht zusammen mit unsortiertem Gemeindeabfall entsorgt werden darf. Das Symbol weist darauf hin, dass das Produkt von regulärem Haushaltsmüll getrennt entsorgt werden sollte. Es liegt in Ihrer Verantwortung, dieses Gerät und andere elektrische und elektronische Geräte über die dafür zuständigen und von der Regierung oder örtlichen Behörden dazu bestimmten Sammelstellen zu entsorgen. Ordnungsgemäßes Entsorgen und Recyceln trägt dazu bei, potentielle negative Folgen für Umwelt und die menschliche Gesundheit zu vermeiden. Wenn Sie weitere Informationen zur Entsorgung Ihrer Altgeräte benötigen, wenden Sie sich bitte an die örtlichen Behörden oder städtischen Entsorgungsdienste oder an den Händler, bei dem Sie das Produkt erworben haben.

## Español

La Directiva 2002/96/CE de la UE exige que los equipos que lleven este símbolo en el propio aparato y/o en su embalaje no deben eliminarse junto con otros residuos urbanos no seleccionados. El símbolo indica que el producto en cuestión debe separarse de los residuos domésticos convencionales con vistas a su eliminación. Es responsabilidad suya desechar este y cualesquiera otros aparatos eléctricos y electrónicos a través de los puntos de recogida que ponen a su disposición el gobierno y las autoridades locales. Al desechar y reciclar correctamente estos aparatos estará contribuyendo a evitar posibles consecuencias negativas para el medio ambiente y la salud de las personas. Si desea obtener información más detallada sobre la eliminación segura de su aparato usado, consulte a las autoridades locales, al servicio de recogida y eliminación de residuos de su zona o pregunte en la tienda donde adquirió el producto.

## Français

La directive européenne 2002/96/CE exige que l'équipement sur lequel est apposé ce symbole sur le produit et/ou son emballage ne soit pas jeté avec les autres ordures ménagères. Ce symbole indique que le produit doit être éliminé dans un circuit distinct de celui pour les déchets des ménages. Il est de votre responsabilité de jeter ce matériel ainsi que tout autre matériel électrique ou électronique par les moyens de collecte indiqués par le gouvernement et les pouvoirs publics des collectivités territoriales. L'élimination et le recyclage en bonne et due forme ont pour but de lutter contre l'impact néfaste potentiel de ce type de produits sur l'environnement et la santé publique. Pour plus d'informations sur le mode d'élimination de votre ancien équipement, veuillez prendre contact avec les pouvoirs publics locaux, le service de traitement des déchets, ou l'endroit où vous avez acheté le produit.

## Italiano

La direttiva europea 2002/96/EC richiede che le apparecchiature contrassegnate con questo simbolo sul prodotto e/o sull'imballaggio non siano smaltite insieme ai rifiuti urbani non differenziati. Il simbolo indica che questo prodotto non deve essere smaltito insieme ai normali rifiuti domestici. È responsabilità del proprietario smaltire sia questi prodotti sia le altre apparecchiature elettriche ed elettroniche mediante le specifiche strutture di raccolta indicate dal governo o dagli enti pubblici locali. Il corretto smaltimento ed il riciclaggio aiuteranno a prevenire conseguenze potenzialmente negative per l'ambiente e per la salute dell'essere umano. Per ricevere informazioni più dettagliate circa lo smaltimento delle vecchie apparecchiature in Vostro possesso, Vi invitiamo a contattare gli enti pubblici di competenza, il servizio di smaltimento rifiuti o il negozio nel quale avete acquistato il prodotto.

# Appendix E: Declaration of Conformity

Česky [Czech]	UBIQUITI NETWORKS tímto prohlašuje, že tento UBIQUITI NETWORKS device, je ve shodě se základními požadavky a dalšími podmínkami ustanovenými směrnicí 1999/5/EC.	Malti [Maltese]	Hawnhekk, UBIQUITI NETWORKS, jiddikjara li dan UBIQUITI NETWORKS device, jikkonforma mal- ti ijjiet essenzjali u ma provvedimenti o rajn relevanti li hemm fid-Dirrettiva 1999/5/EC.
Dansk [Danish]	Undertegnede UBIQUITI NETWORKS erklærer herved, at følgende udstyr UBIQUITI NETWORKS device, overholder de væsentlige krav og øvrige relevante krav i direktiv 1999/5/EF.	Norsk [Norwegian]	UBIQUITI NETWORKS erklærer herved at utstyret UBIQUITI NETWORKS device, er i samsvar med de grunnleggende krav og øvrige relevante krav i direktiv 1999/5/EF.
Nederlands [Dutch]	Hierbij verklaart UBIQUITI NETWORKS dat het toestel UBIQUITI NETWORKS device, in overeenstemming is met de essentiële eisen en de andere relevante bepalingen van richtlijn 1999/5/EG. Bij deze verklaart UBIQUITI NETWORKS dat deze UBIQUITI NETWORKS device, voldoet aan de essentiële eisen en aan de overige relevante bepalingen van Richtlijn 1999/5/EC.	Slovensky [Slovak]	UBIQUITI NETWORKS týmto vyhlasuje, že UBIQUITI NETWORKS device, spĺa základné požiadavky a v etky príslušné ustanovenia Smernice 1999/5/ES.
English	Hereby, UBIQUITI NETWORKS, declares that this UBIQUITI NETWORKS device, is in compliance with the essential requirements and other relevant provisions of Directive 1999/5/EC.	Svenska [Swedish]	Härmed intygar UBIQUITI NETWORKS att denna UBIQUITI NETWORKS device, står i överensstämmelse med de väsentliga egenskapskrav och övriga relevanta bestämmelser som framgår av direktiv 1999/5/EG.
Eesti [Estonian]	Käesolevaga kinnitab UBIQUITI NETWORKS seadme UBIQUITI NETWORKS device, vastavust direktiivi 1999/5/EÜ põhinõuetele ja nimetatud direktiivist tulenevatele teistele asjakohastele sätetele.	Español [Spanish]	Por medio de la presente UBIQUITI NETWORKS declara que el UBIQUITI NETWORKS device, cumple con los requisitos esenciales y cualesquiera otras disposiciones aplicables o exigibles de la Directiva 1999/5/CE.
Suomi [Finnish]	UBIQUITI NETWORKS vakuuttaa täten että UBIQUITI NETWORKS device, tyypinen laite on direktiivin 1999/5/EY oleellisten vaatimusten ja sitä koskevien direktiivin muiden ehtojen mukainen.	Polski [Polish]	Niniejszym, firma UBIQUITI NETWORKS o wiadcza, że produkt serii UBIQUITI NETWORKS device, spełnia zasadnicze wymagania i inne istotne postanowienia Dyrektywy 1999/5/EC.
Français [French]	Par la présente UBIQUITI NETWORKS déclare que l'appareil UBIQUITI NETWORKS device est conforme aux exigences essentielles et aux autres dispositions pertinentes de la directive 1999/5/CE. Par la présente, UBIQUITI NETWORKS déclare que ce UBIQUITI NETWORKS device, est conforme aux exigences essentielles et aux autres dispositions de la directive 1999/5/CE qui lui sont applicables.	Português [Portuguese]	UBIQUITI NETWORKS declara que este UBIQUITI NETWORKS device, está conforme com os requisitos essenciais e outras disposições da Directiva 1999/5/CE.
Deutsch [German]	Hiermit erklärt UBIQUITI NETWORKS, dass sich diese UBIQUITI NETWORKS device, in Übereinstimmung mit den grundlegenden Anforderungen und den anderen relevanten Vorschriften der Richtlinie 1999/5/EG befindet“. (BMW) Hiermit erklärt UBIQUITI NETWORKS die Übereinstimmung des Gerätes UBIQUITI NETWORKS device, mit den grundlegenden Anforderungen und den anderen relevanten Festlegungen der Richtlinie 1999/5/EG. (Wien)	Română [Romanian]	Prin prezenta, UBIQUITI NETWORKS declară că acest dispozitiv UBIQUITI NETWORKS este în conformitate cu cerințele esențiale și alte prevederi relevante ale Directivei 1999/5/CE.
Ελληνική [Greek]	ΜΕ ΤΗΝ ΠΑΡΟΥΣΑ UBIQUITI NETWORKS ΔΗΛΩΝΕΙ ΟΤΙ UBIQUITI NETWORKS device, ΣΥΜΜΟΡΦΩΝΕΤΑΙ ΠΡΟΣ ΤΙΣ ΟΥΣΙΩΔΕΙΣ ΑΠΑΙΤΗΣΕΙΣ ΚΑΙ ΤΙΣ ΛΟΙΠΕΣ ΣΧΕΤΙΚΕΣ ΔΙΑΤΑΞΕΙΣ ΤΗΣ ΟΔΗΓΙΑΣ 1999/5/EC.		
Magyar [Hungarian]	Alulírott, UBIQUITI NETWORKS nyilatkozom, hogy a UBIQUITI NETWORKS device, megfelel a vonatkozó alapvető követelményeknek és az 1999/5/EC irányelv egyéb előírásainak.		
Íslenska [Icelandic]	Hér með tilkynni UBIQUITI NETWORKS yfir ví a UBIQUITI NETWORKS device, er í samræmi við grunnkröfur og a rar kröfur, sem ger ar eru í tilskipun 1999/5/EC.		
Italiano [Italian]	Con la presente UBIQUITI NETWORKS dichiara che questo UBIQUITI NETWORKS device, è conforme ai requisiti essenziali ed alle altre disposizioni pertinenti stabilite dalla direttiva 1999/5/CE.		
Latviski [Latvian]	Ar o UBIQUITI NETWORKS deklar, ka UBIQUITI NETWORKS device, atbilst Direkt vas 1999/5/EK b tiskaj m pras b m un citiem ar to saist tajiem noteikumiem.		
Lietuviškai [Lithuanian]	UBIQUITI NETWORKS deklaruoja, kad šis UBIQUITI NETWORKS įrenginys atitinka esminius reikalavimus ir kitas 1999/5/EB Direktyvos nuostatas.		

## Appendix F: Contact Information

---

### Ubiquiti Networks Support

Ubiquiti Support Engineers are located around the world and are dedicated to helping customers resolve software, hardware compatibility, or field issues as quickly as possible. We strive to respond to support inquiries within a 24-hour period.

Email: [support@ubnt.com](mailto:support@ubnt.com)

Phone: 408-942-1153 (9 a.m. - 5 p.m. PST)

### Online Resources

Wiki Page: [wiki.ubnt.com](http://wiki.ubnt.com)

Support Forum: [forum.ubnt.com](http://forum.ubnt.com)

Downloads: [downloads.ubnt.com](http://downloads.ubnt.com)



2580 Orchard Parkway  
San Jose, CA 95131

[www.ubnt.com](http://www.ubnt.com)

© 2012 Ubiquiti Networks, Inc. All rights reserved. TOUGHSwitch™ and Ubiquiti Networks™ are trademarks of Ubiquiti Networks, Inc.